

INX 611 Specifications

- Modern functional design
- Single bowl, single drainer format
- Extra large multi-purpose bowl
- 90mm Waste with Basket Strainer Waste. Capable of adaptation to take Waste Disposal Unit
- Waste at rear of bowl
- 3 colours of bespoke accessories available
- Available as a Designer Value Pack

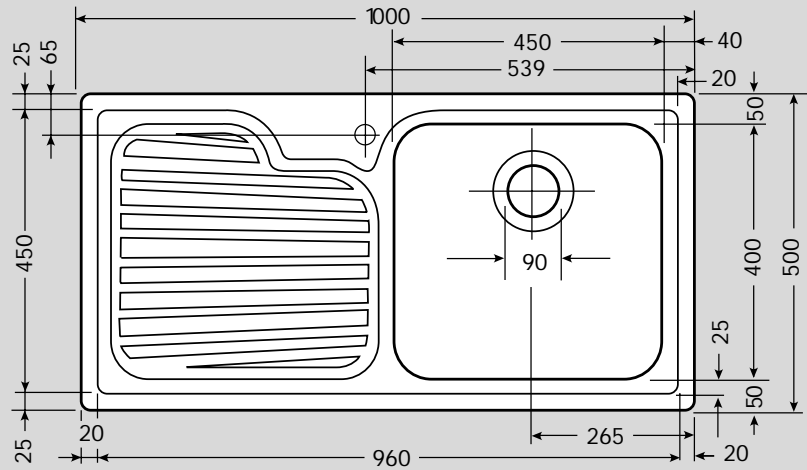

Material: 304 Austenitic 18/10 Stainless Steel

Application: Inset

Bowl size: 450 x 400 x 190
(Bowl welded to frame)

Drainer Format: Left or right hand drainer available

Cut-out size: 980 x 480 (R=20)

Colour: Satin Stainless Steel

Seal: Sealing strip supplied

Insulation: Factory fitted black pads

Heat Resistance: Up to 300°C

Earthing Point: Utilise clip rail slots

Cabinet size:

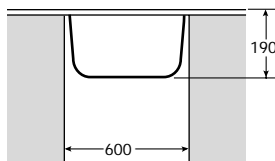

Sink Profile: Folded edge

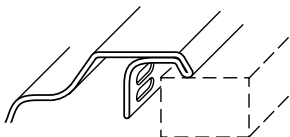

Fixing Clips:

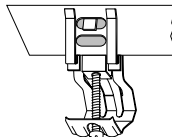

Suggested Plumbing Kit: 1 part

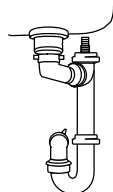

Waste: 1 x Lira 90mm Basket Strainer Waste with overflow

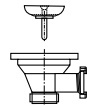

Overflow:



Accessories available:



Chopping Board
Mahogany

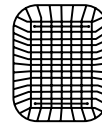

Drainer Basket
Available in White,
Almond or Brown

Taps: Any Franke tap can be utilised with this model*.

*Ceramic disc taps in certain installations or where there is a low head of water (below 3 metres) may not provide adequate flow rates. You are advised to check with your supplier.

Some taps may need bracing to avoid flexing of the sink ledge.

Guarantee: Franke sinks are guaranteed for 25 years against manufacturing defect. Franke taps are guaranteed against defective materials and workmanship for 1 year in relation to coatings and finishes, and 5 years in relation to moving parts. Franke will replace (and where appropriate repair) defective sinks. In relation to taps, Franke will where appropriate provide replacement parts for your taps or replace your taps. Any associated or ancillary costs to be incurred by you as a result of replacement of Franke sinks and taps under this guarantee shall in all cases be previously approved by Franke UK Limited.

This guarantee is in addition to and does not affect your statutory rights.